



## Super Precision Bearings

MOTION & CONTROL™

**NSK**

know-how makes the difference

**ERIKS**

**ERIKS, the natural choice for your NSK Super Precision Bearings:**

- Extensive stocks – excellent availability and a nationwide network of 80+ Service Centres
- Technical support – in-house expertise, manufacturer trained, means quick advice on suitable alternatives and upgrades
- Authorised distributor – full manufacture back up, warrantee and guaranteed genuine products

**NSK Super Precision Bearings allow for high speed and accurate running while maintaining extreme rigidity - ranges include:**

**Super Precision Ball Bearings**

Primarily used in machine tool spindles (typical example pictured below). Their performance is essential to the final accuracy of the components produced.

Within this brochure you will find a brief introduction to NSK Super Precision Bearings and their benefits, including a section on upgrading to allow for better performance, increased life and reliability.

**High Precision Cylindrical Roller Bearings**

Used where there are large radial loads and lower speeds.

For further information and technical advice on specifications, availability and potential upgrades for NSK Super Precision Bearings, please contact ERIKS.

**High Precision Ball Screw Support Ball Bearings**

Used at the ends of a ball screw to offer accurate location and support large axial loads.

The NSK Newark Super Precision Factory is one of only two global centres of manufacturing excellence for NSK super precision bearings. Within the specially designed facility, production takes place in a medically clean environment to ensure product quality and the UK based factory enables quick lead times.

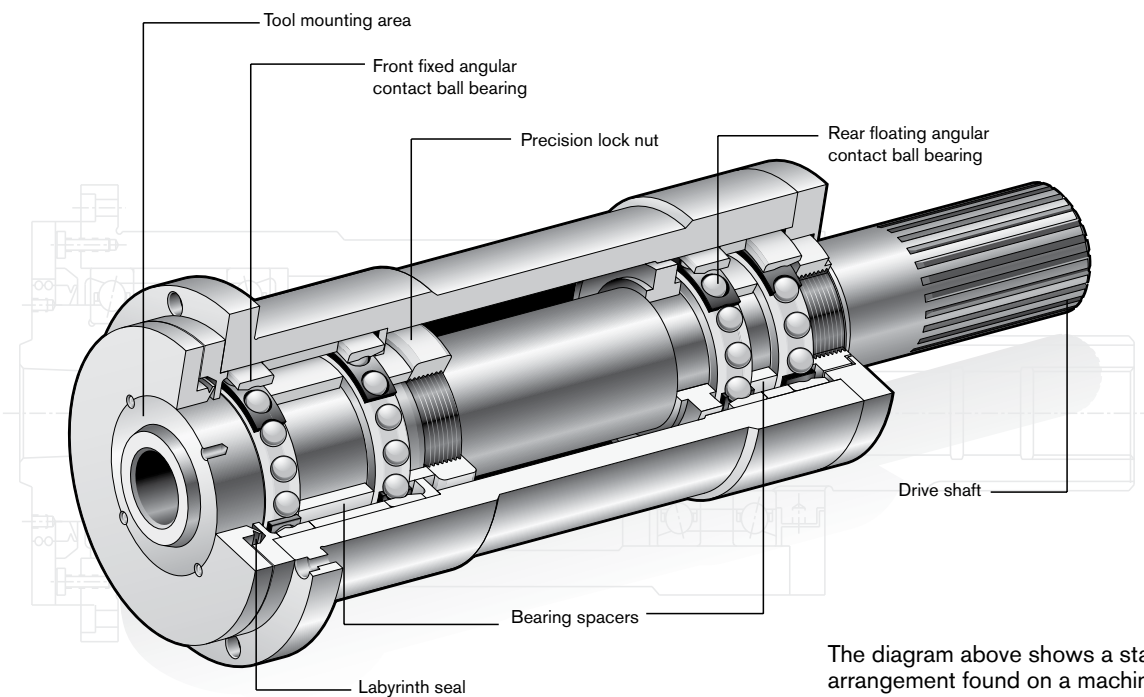

The diagram above shows a standard bearing arrangement found on a machine tool spindle.

# Common Features of Precision Bearings

The following features need to be specified when ordering an NSK precision bearing:

## Contact Angle

The angle (measured from a vertical position) where the balls run and locate on the raceway. Increasing the angle has the effect of increasing axial load carrying performance; however it decreases radial load performance and running speed. The contact angle allows loads to be taken in both radial and axial directions.

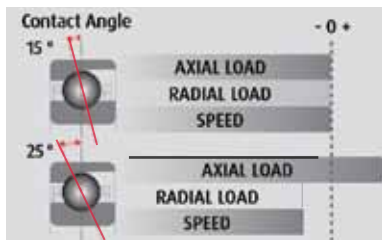

### Sample part numbers

7905CTRSULP3-NSK

7905A5TRISULP3-NSK

15° contact angle is the most common variant of super precision bearings; this is because it offers good rigidity while maintaining high speed and good load capacity.

25° contact angle is used when higher axial loads are required but cannot run as fast as a 15° contact angle.

If the desired contact angle is unavailable, please contact ERIKS. Depending on the loads and speed, other options may be viable in the application.

## Preload

The preload is a measure of the rigidity inside the bearing. All Super Precision Angular Contact Ball Bearings must run with some preload. It is important to note that as preload is increased the rigidity will be higher but the speed and life will reduce.

### Preload Sample part numbers

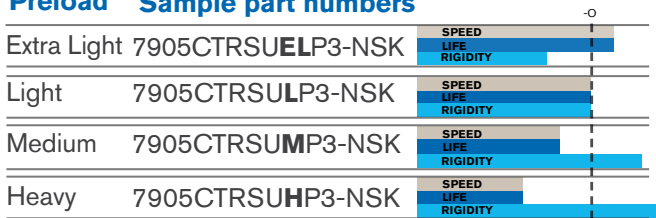

There are four standard preload options available from NSK which offer a large range of rigidity and interchangeability.

If the desired preload is unavailable, please contact ERIKS. Depending on the loads and speed, other options may be viable in the application.

## Precision Class

Precision grade determines the dimensional accuracy and run-out\* of the bearing. The precision can be increased with no side effects.

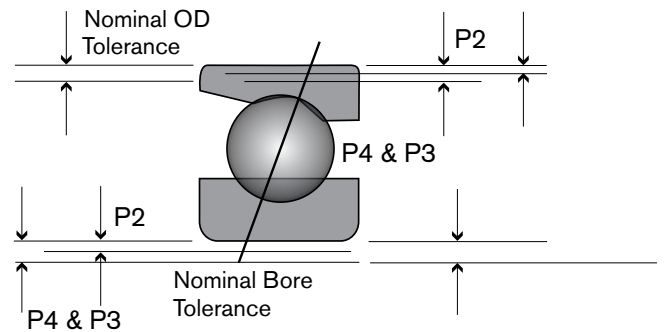

	Precision	Sample part numbers
Lowest	P5/ABEC5/EP5	7905CTRSUMP5-NSK
	P4/ABEC7/EP7	7905CTRSUMP4-NSK
	P3 P2 Runout and P4 External Tolerances	7905CTRSUMP3-NSK
Highest	P2/ABEC9/EP9	7905CTRSUMP2-NSK

\* Run-out is the rotary deviation between the housing and the shaft on a single rotation, in the vertical, radial or the horizontal, axial plane.

## Arrangements

Super Precision Angular Contact Ball Bearings are arranged in application in order to handle loads from multiple directions. The load travels through the lines of the contact angles, normally to form an O-arrangement, back to back, or X-arrangement, face to face.

To account for the loadings in an application, multiple bearings will be used in an assembly normally 1 (single), 2 (duplex), 3 (triplex), 4 (quadplex), etc.

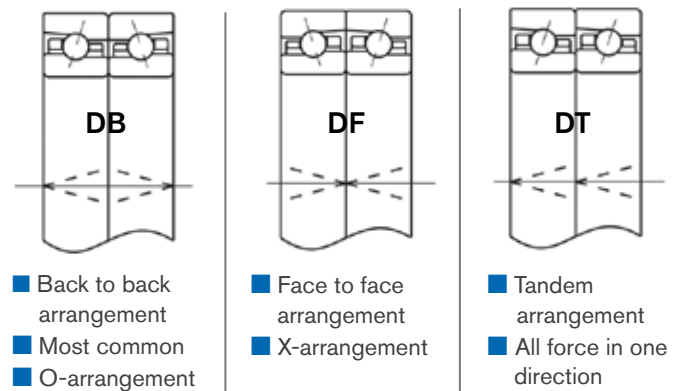

If a bearing is labelled as Universal then it means it can be fitted into any of the above arrangements.

# Product Range

## High Precision Angular Contact Ball Bearings



Standard Series

- Sizes to ISO standards
- Standard range of high speed angular contact bearings

## Ultra High-Speed Angular Contact Ball Bearings



Robust Series BNR, BER Series

- Can run at extreme speed
- Will last longer than a standard in the same application

### Conventional Type 72, 70, 79 Series

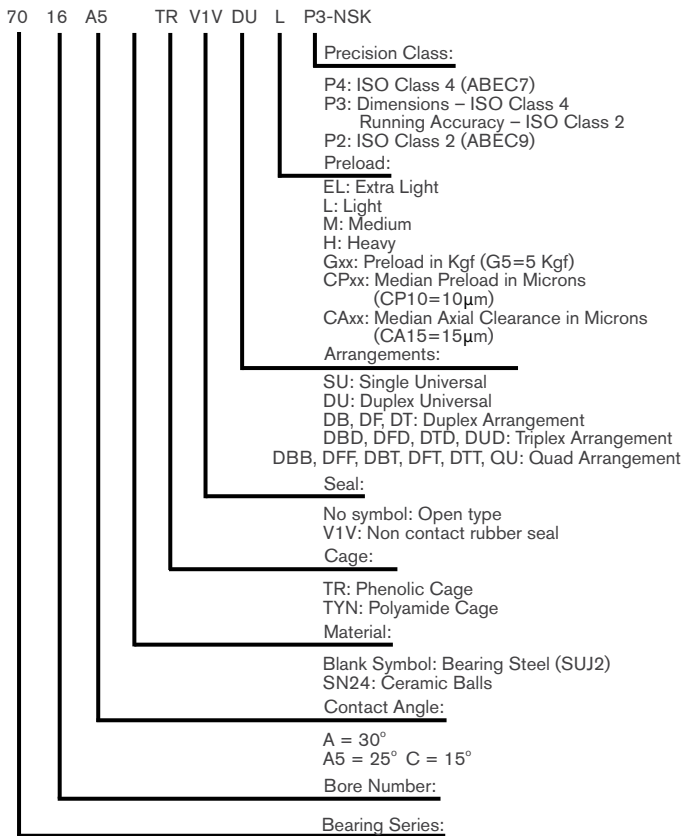

### Robust Series, High-Speed Type

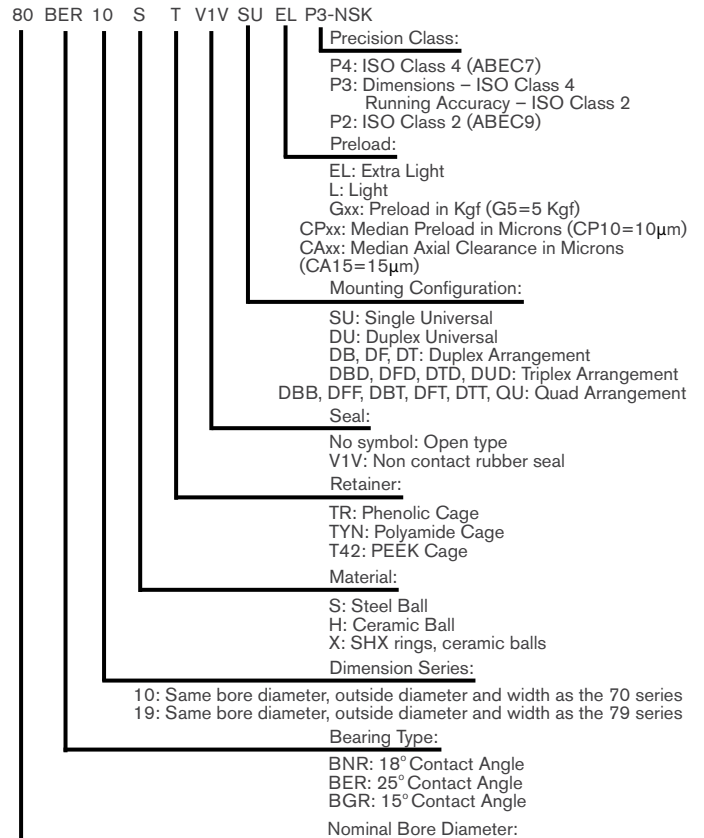

# Product Range

## Angular Contact Thrust Ball Bearings for Ball Screw Support



**Special Series for Machine Tool Applications**

- High contact angle (60°) for large axial support
- Designed to provide good guidance

## Double Row Cylindrical Roller Bearings



**Double Standard and High Rigidity Series**

- Two rows of rollers offering high radial capacity

## Ultra High-Speed Single Row Cylindrical Roller Bearings



**Single Standard and Robust Series**

- Can run at extreme speeds
- At the top of its specification can run as fast as most super precision ball bearings

### Ball Screw Support Bearings

30 TAC 62 B DDG SU C10 PN7B-NSK

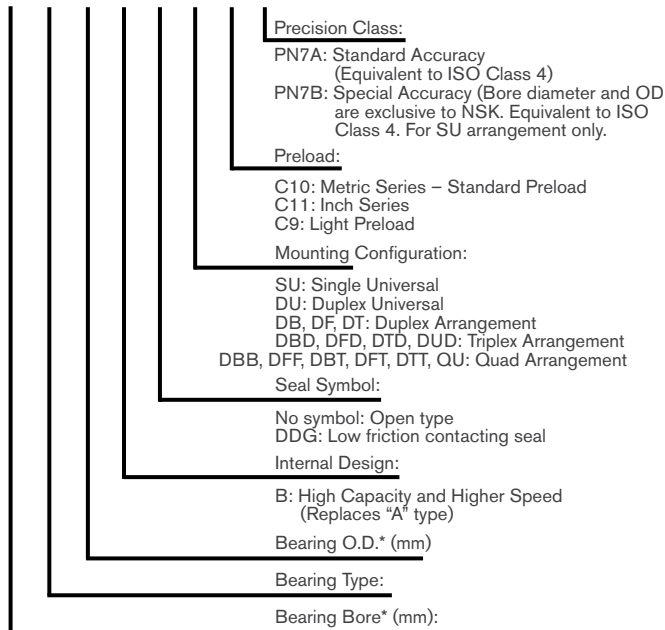

### Cylindrical Roller Bearings

NN 3 0 17 MB KR E44 CC0 P4-NSK

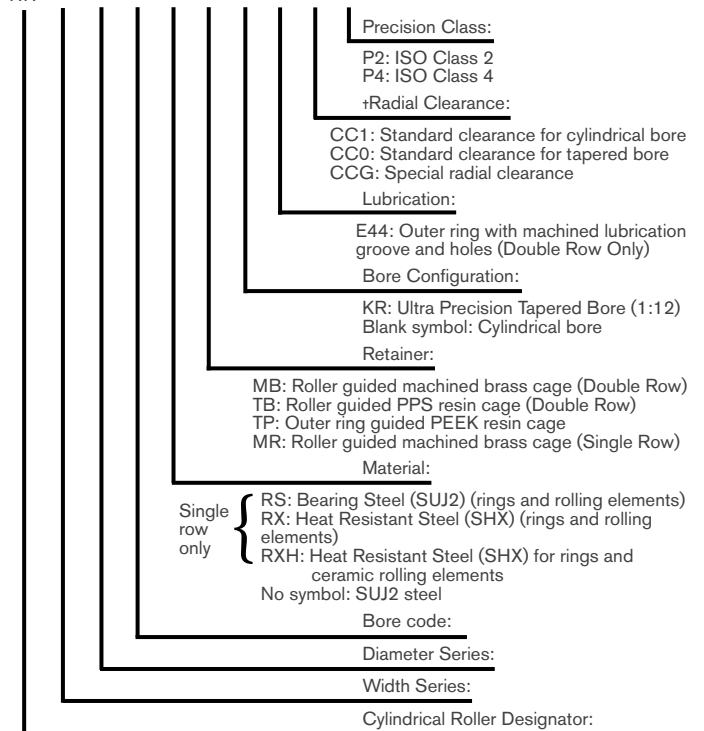

NN: Double Row, Inner Ring Guided Rollers  
N: Single Row, Inner Ring Guided Rollers

\* For inch series bearings, the fractional portion of the size is omitted.

† CC0 clearance (NSK's recommended clearance)

CC0 clearance range less than CC1. This range overlaps with the upper values of CC1, as this clearance is easy for customers to target this range, it is the preferred clearance offered for CRB with taper bore.

CC1 clearance matched clearance range greater than CC0. While not the standard, this clearance is most popular in the field.



# Upgrades

A range of features to improve the performance or life of a precision bearing in application. These upgrades can lead to operational cost savings far outweighing the initial cost of the product.

## Hybrid Bearings

Upgrading to hybrid (steel ringed bearings using silicon nitride ceramic balls bearings) increases reliability and performance.

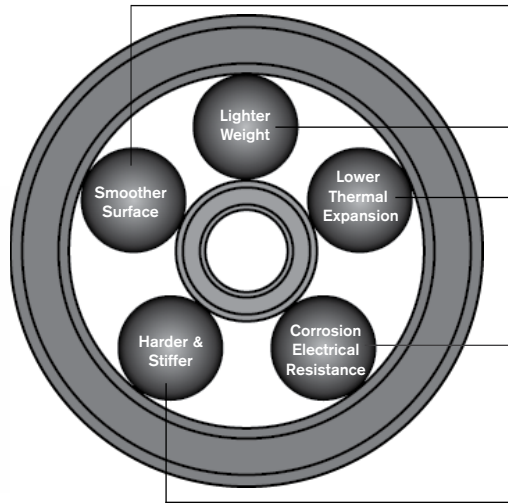

**Smoother Surface** – improves the accuracy of rotation and components being manufactured

**Lighter Weight** – can run up to 25% faster generating a lower temperature

**Corrosion & Electrical Resistance** – can be run in more arduous environments, electrical resistance prevents pitting of the ball surface due to electrical discharge

**Harder & Stiffer** – less likely to be damaged by small amounts of hard contamination and will distort less under high load

## Sample part numbers

Standard Precision Product:  
7014CSN24TRSULP3-NSK

High-Speed 'Robust' Product:  
70BNR10HTSULP3-NSK

## Benefits

- Higher speed
- Cooler temperature
- Higher reliability
- Longer life
- Higher accuracy

Graph on the right shows for actual set of running conditions that hybrid bearings run considerably cooler than conventional bearings.

Temperature Rise (°C)

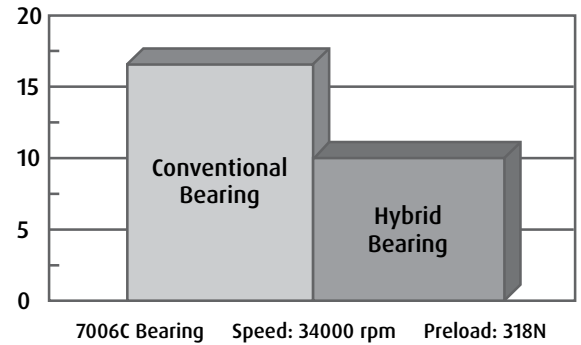

## Sealed Bearings

Upgrading to sealed bearings has a major advantage of increasing life and performance of spindle bearings. Sealed angular contact bearings have the same external dimensions as open bearing so interchange is easy.

## Benefits

- Reduced external contamination in application – higher accuracy
- Grease in optimum quantity and position – time saving for end user
- Clean handling
- No grease migration in application – improved performance
- Longer grease life – 1.5 times the life of an open greased bearing

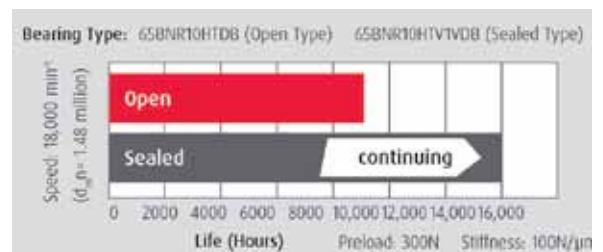

Experimentation showed that in the above conditions sealed bearings had considerably longer life.

# Care Instructions

## Storage

### Global Packaging

When NSK bearings are supplied in the new global packaging specification, (pictured to the right), there is no need to pre-wash the bearings before mounting.



The global packaging has the following features:

- Low viscosity preservative oil that is chemically compatible with common machine tool bearing greases
- VPI (Vapour Phase Inhibitor) impregnated into the nylon polyethylene laminated bag. This gives extra corrosion protection
- Bearing vacuum packed and heat-sealed for added protection from the outside environment

This same packaging method is used for factory greased bearings and all sealed bearings. So there is no need to pre-clean the bearings before mounting.



## Fitting

### Press Fit

Press fits tend to be used for smaller bearings typically less than 30mm bore. It is usual to lightly oil the mating parts in order to reduce the force required for fitting. When fitting the inner ring, care should be taken to ensure the press force is directed through the inner ring. In the diagram shown, a hole can be seen in the pressing piece to allow air to escape.

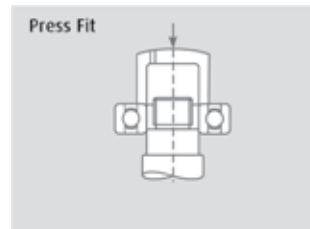

### Induction Heating

The Volcano portable induction heater is perfect when the bearing is too large to press fit. It heats the bearing from the inner rings which expands it allowing it to be easily fitted over the shaft without causing any damage.



## Assembly

Care should be taken when assembling bearings into the housing. Usually a clearance fit is used but if alignment is not true it could be possible to damage or dismantle a bearing. Heating the housing using an air gun helps to increase the clearance and avoid this problem.

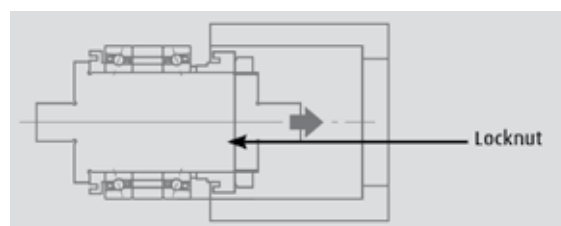

Call 0845 006 6000  
[www.eriks.co.uk](http://www.eriks.co.uk)

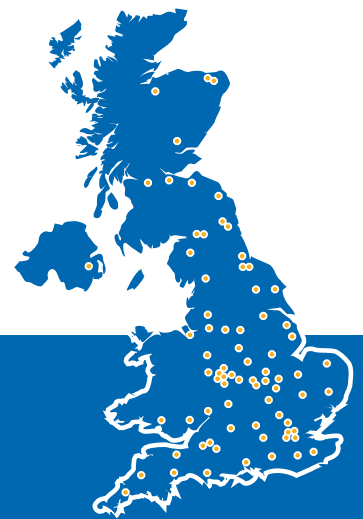

ERIKS UK

Amber Way, Halesowen,  
West Midlands, B62 8WG



**ERIKS**